

2210 E-2RS1TN9

Dimensions

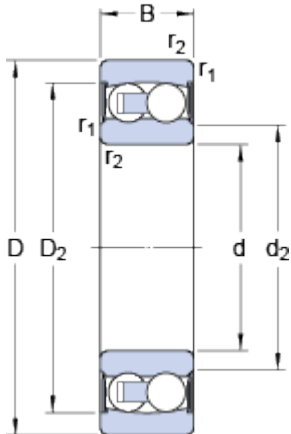

d		50	mm
D		90	mm
B		23	mm
d ₂	≈	57.7	mm
D ₂	≈	79.4	mm
r _{1,2}	min.	1.1	mm

Abutment dimensions

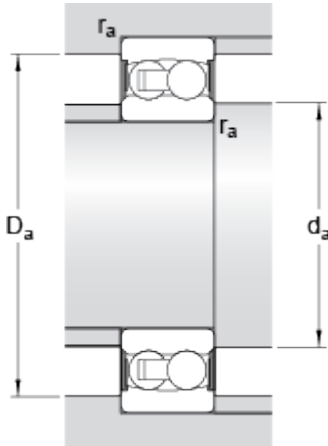

d _a	min.	57	mm
d _a	max.	58	mm
D _a	max.	83	mm
r _a	max.	1.1	mm

Calculation data

Basic dynamic load rating	C	22.9	kN
Basic static load rating	C	8.15	kN
Fatigue load limit	P _u	0.42	kN
Limiting speed		4800	r/min
Permissible angular misalignment	α	1.5	°
Calculation factor	k _r	0.045	
Calculation factor	e	0.2	
Calculation factor	Y	3.2	
Calculation factor	Y ₁	3.2	
Calculation factor	Y ₂	4.9	

Mass

Mass bearing		0.57	kg
--------------	--	------	----