

21167

Dimensions

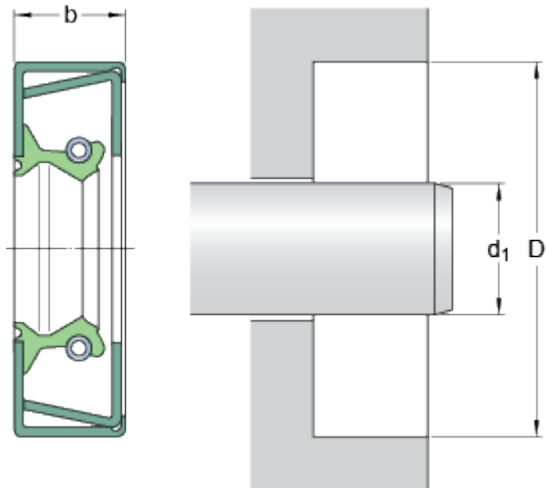

d_1	53.975	mm
D	76.2	mm
b	7.95	mm

Application and operating conditions

Pressure differential	max.	0.07	MPa
Operating temperature	min.	-40	°C
Operating temperature	max.	200	°C
Operating temperature, short period	max.	220	°C
Rotational speed	max.	6369	r/min
Shaft surface speed	max.	18	m/s