

13571

Dimensions

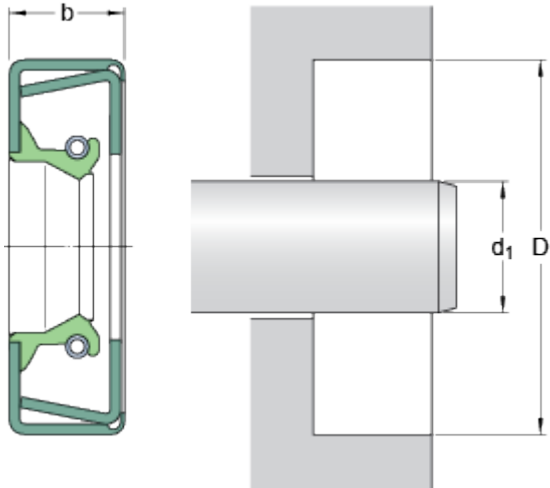

d_1	34.925	mm
D	50.8	mm
b	7.95	mm

Application and operating conditions

Pressure differential	max.	0.07	MPa
Operating temperature	min.	-40	°C
Operating temperature	max.	100	°C
Operating temperature, short period	max.	120	°C
Rotational speed	max.	9843	r/min
Shaft surface speed	max.	18	m/s