

# 13545

## Dimensions

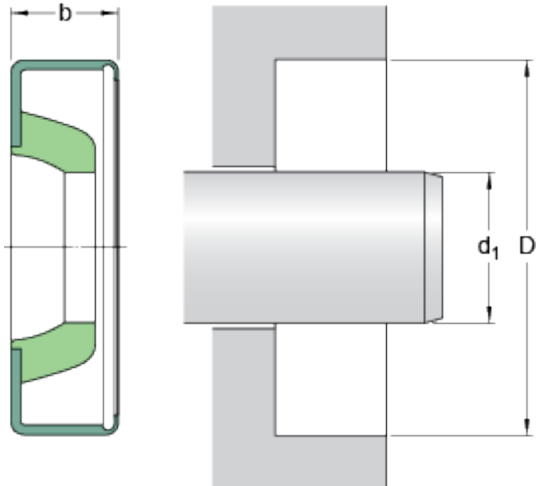

$d_1$	34.925	mm
D	47.6	mm
b	6.35	mm

## Application and operating conditions

Pressure differential	max.	0.07	MPa
Operating temperature	min.	-40	°C
Operating temperature	max.	150	°C
Operating temperature, short period	max.	175	°C
Rotational speed	max.	5468	r/min
Shaft surface speed	max.	10	m/s