

12x24x6 HMSA7P2 R

Dimensions

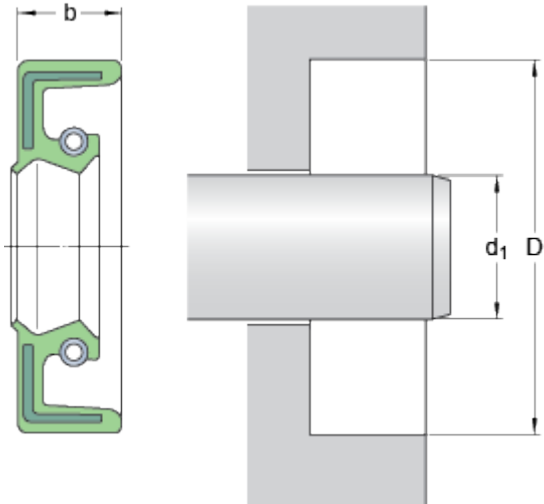

d_1	12	mm
D	24	mm
b	6	mm

Application and operating conditions

Operating temperature	min.	-40	°C
Operating temperature	max.	100	°C
Operating temperature, short period	max.	120	°C