

127 TN9

Dimensions



d	7	mm
D	22	mm
B	7	mm
d ₁	≈ 12.709	mm
D ₁	≈ 17.6	mm
r _{1,2}	min. 0.3	mm

Abutment dimensions

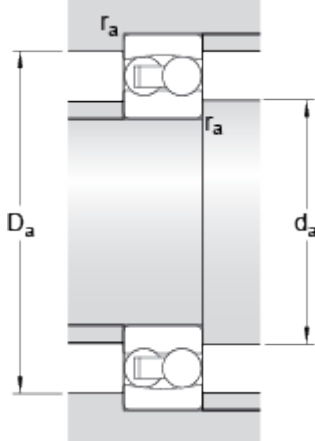

d _a	min. 9.4	mm
D _a	max. 19.6	mm
r _a	max. 0.3	mm

Calculation data

Basic dynamic load rating	C	2.65	kN
Basic static load rating	C	0.56	kN
Fatigue load limit	P _u	0.029	kN
Reference speed		63000	r/min
Limiting speed		40000	r/min
Permissible angular misalignment	α	3	°
Calculation factor	k _r	0.04	
Calculation factor	e	0.33	
Calculation factor	Y	2	
Calculation factor	Y ₁	1.9	
Calculation factor	Y ₂	3	

Mass

Mass bearing	0.014	kg
--------------	-------	----

