

12334

Dimensions

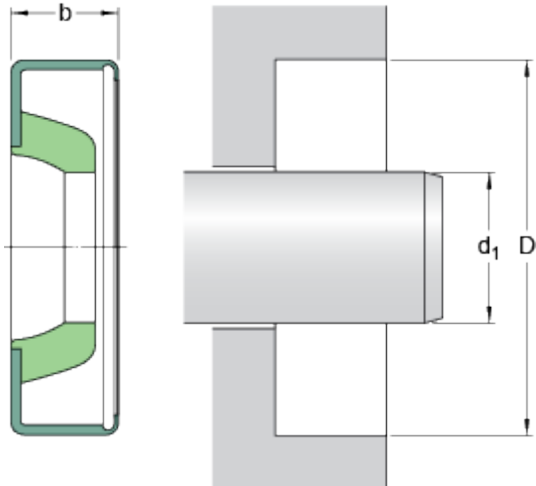

d_1	31.75	mm
D	42.82	mm
b	4.78	mm

Application and operating conditions

Pressure differential	max.	0.07	MPa
Operating temperature	min.	-40	°C
Operating temperature	max.	100	°C
Operating temperature, short period	max.	120	°C
Rotational speed	max.	6015	r/min
Shaft surface speed	max.	10	m/s