

# 12330

## Dimensions

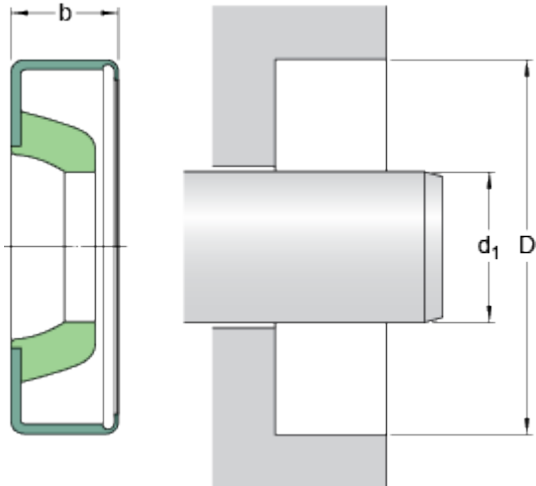

$d_1$	31.75	mm
D	38.1	mm
b	6.35	mm

## Application and operating conditions

Pressure differential	max.	0.07	MPa
Operating temperature	min.	-40	°C
Operating temperature	max.	100	°C
Operating temperature, short period	max.	120	°C
Rotational speed	max.	6015	r/min
Shaft surface speed	max.	10	m/s